

HEF40098B

Hex inverting buffer; 3-state

Rev. 9 — 18 March 2016

Product data sheet

1. General description

The HEF40098B is a hex inverting buffer with 3-state outputs. The 3-state outputs are controlled by two active LOW enable inputs ($\overline{1OE}$ and $\overline{2OE}$). A HIGH on $\overline{1OE}$ causes four of the six active LOW buffer elements ($\overline{1Y0}$ to $\overline{1Y3}$) to assume a high-impedance or OFF-state regardless of the other input conditions and a HIGH on $\overline{2OE}$ causes the outputs of the remaining two buffer elements ($\overline{2Y0}$ and $\overline{2Y1}$) to assume a high-impedance or OFF-state regardless of the other input conditions.

It operates over a recommended V_{DD} power supply range of 3 V to 15 V referenced to V_{SS} (usually ground). Unused inputs must be connected to V_{DD} , V_{SS} , or another input.

2. Features and benefits

- Fully static operation
- 5 V, 10 V, and 15 V parametric ratings
- Standardized symmetrical output characteristics
- Specified from $-40\text{ }^{\circ}\text{C}$ to $+85\text{ }^{\circ}\text{C}$
- Complies with JEDEC standard JESD 13-B

3. Ordering information

Table 1. Ordering information

All types operate from $-40\text{ }^{\circ}\text{C}$ to $+85\text{ }^{\circ}\text{C}$

Type number	Package		
	Name	Description	Version
HEF40098BT	SO16	plastic small outline package; 16 leads; body width 3.9 mm	SOT109-1

4. Functional diagram

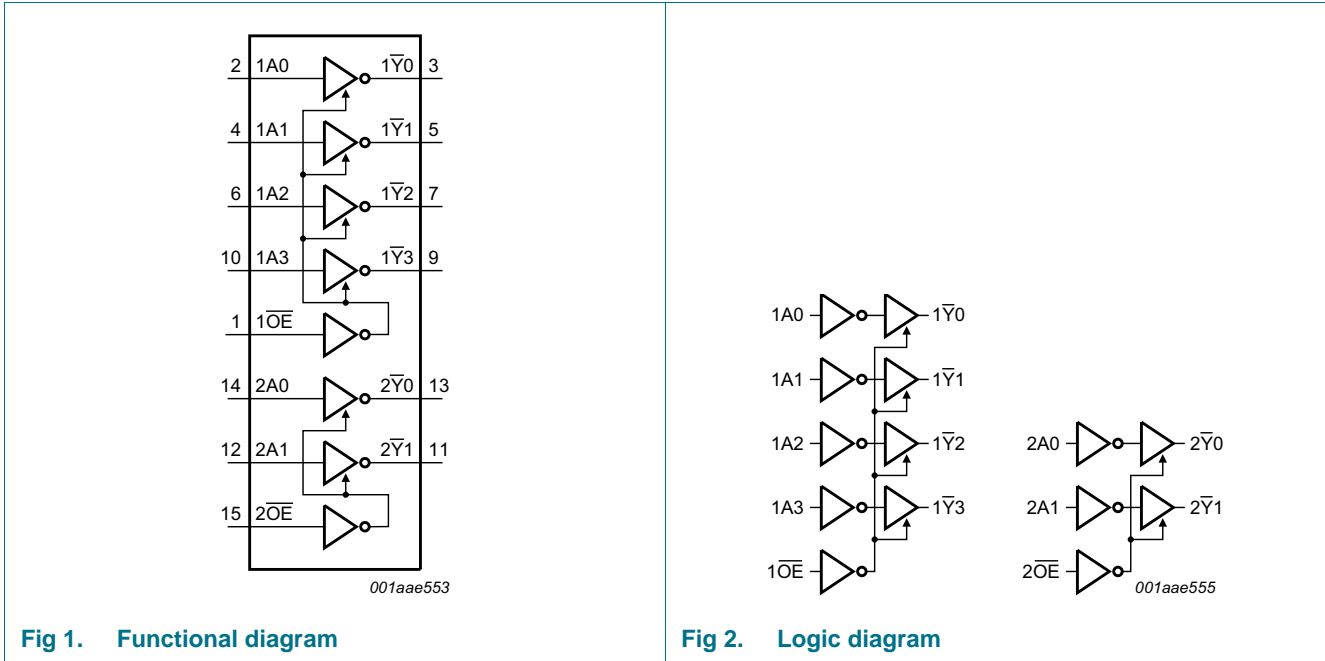

Fig 1. Functional diagram

Fig 2. Logic diagram

5. Pinning information

5.1 Pinning

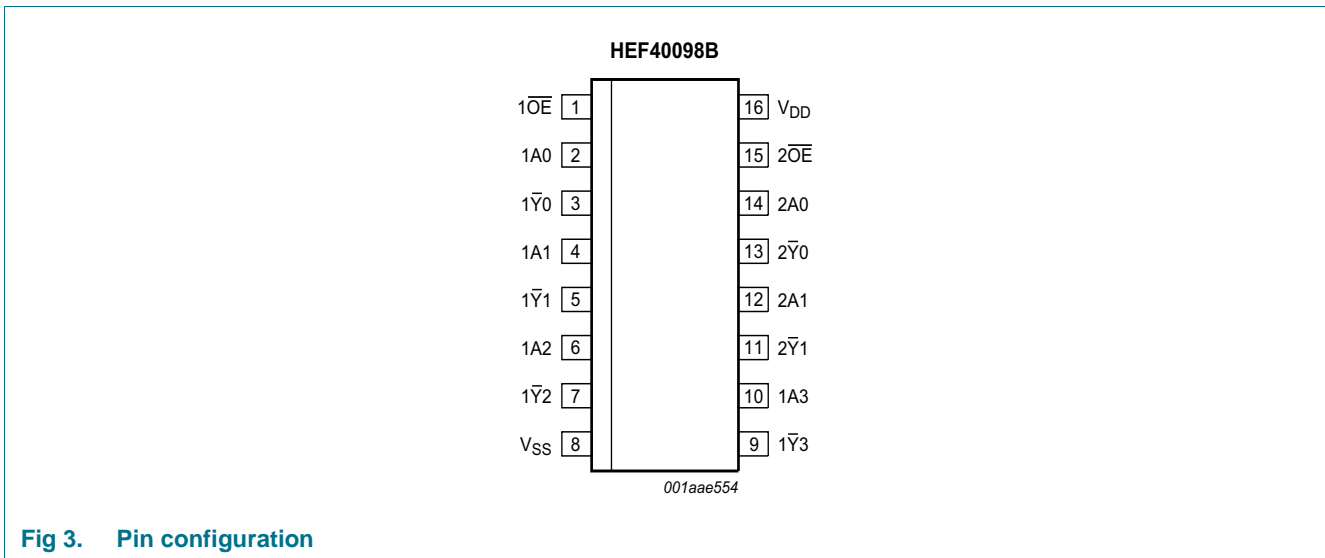

Fig 3. Pin configuration

5.2 Pin description

Table 2. Pin description

Symbol	Pin	Description
$1\overline{OE}$	1	output enable input (active LOW)
1A0, 1A1, 1A2, 1A3	2, 4, 6, 10	buffer input
$1\overline{Y0}$, $1\overline{Y1}$, $1\overline{Y2}$, $1\overline{Y3}$	3, 5, 7, 9	buffer output (active LOW)
V_{SS}	8	supply voltage
$2\overline{Y0}$, $2\overline{Y1}$	13, 11	buffer output (active LOW)
2A0, 2A1	14, 12	buffer input
$2\overline{OE}$	15	output enable input (active LOW)
V_{DD}	16	supply voltage

6. Functional description

Table 3. Function table^[1]

Inputs		Output
nAn	\overline{nOE}	\overline{nYn}
H	L	L
L	L	H
X	H	Z

[1] H = HIGH voltage level; L = LOW voltage level; X = don't care; Z = high-impedance OFF-state.

7. Limiting values

Table 4. Limiting values

In accordance with the Absolute Maximum Rating System (IEC 60134).

Symbol	Parameter	Conditions	Min	Max	Unit
V_{DD}	supply voltage		-0.5	+18	V
I_{IK}	input clamping current	$V_I < -0.5\text{ V}$ or $V_I > V_{DD} + 0.5\text{ V}$	-	± 10	mA
V_I	input voltage		-0.5	$V_{DD} + 0.5$	V
I_{OK}	output clamping current	$V_O < -0.5\text{ V}$ or $V_O > V_{DD} + 0.5\text{ V}$	-	± 10	mA
$I_{I/O}$	input/output current		-	± 10	mA
I_{DD}	supply current		-	50	mA
T_{stg}	storage temperature		-65	+150	°C
T_{amb}	ambient temperature		-40	+85	°C
P_{tot}	total power dissipation	$T_{amb} = -40\text{ to }+85\text{ °C}$			
		SO16 package ^[1]	-	500	mW
P	power dissipation		-	100	mW

[1] For SO16 package: P_{tot} derates linearly with 8 mW/K above 70 °C.

8. Recommended operating conditions

Table 5. Recommended operating conditions

Symbol	Parameter	Conditions	Min	Typ	Max	Unit
V_{DD}	supply voltage		3	-	15	V
V_I	input voltage		0	-	V_{DD}	V
T_{amb}	ambient temperature	in free air	-40	-	+85	°C
$\Delta t/\Delta V$	input transition rise and fall rate	$V_{DD} = 5\text{ V}$	-	-	3.75	ns/V
		$V_{DD} = 10\text{ V}$	-	-	0.5	ns/V
		$V_{DD} = 15\text{ V}$	-	-	0.08	ns/V

9. Static characteristics

Table 6. Static characteristics

$V_{SS} = 0\text{ V}$; $V_I = V_{SS}$ or V_{DD} ; unless otherwise specified.

Symbol	Parameter	Conditions	V_{DD}	$T_{amb} = -40\text{ °C}$		$T_{amb} = 25\text{ °C}$		$T_{amb} = 85\text{ °C}$		Unit
				Min	Max	Min	Max	Min	Max	
V_{IH}	HIGH-level input voltage	$ I_O < 1\text{ }\mu\text{A}$	5 V	3.5	-	3.5	-	3.5	-	V
			10 V	7.0	-	7.0	-	7.0	-	V
			15 V	11.0	-	11.0	-	11.0	-	V
V_{IL}	LOW-level input voltage	$ I_O < 1\text{ }\mu\text{A}$	5 V	-	1.5	-	1.5	-	1.5	V
			10 V	-	3.0	-	3.0	-	3.0	V
			15 V	-	4.0	-	4.0	-	4.0	V
V_{OH}	HIGH-level output voltage	$ I_O < 1\text{ }\mu\text{A}$	5 V	4.95	-	4.95	-	4.95	-	V
			10 V	9.95	-	9.95	-	9.95	-	V
			15 V	14.95	-	14.95	-	14.95	-	V
V_{OL}	LOW-level output voltage	$ I_O < 1\text{ }\mu\text{A}$	5 V	-	0.05	-	0.05	-	0.05	V
			10 V	-	0.05	-	0.05	-	0.05	V
			15 V	-	0.05	-	0.05	-	0.05	V
I_{OH}	HIGH-level output current	$V_O = 2.5\text{ V}$	5 V	-	-3.8	-	-3.2	-	-2.5	mA
		$V_O = 4.6\text{ V}$	5 V	-	-1.2	-	-1.0	-	-0.8	mA
		$V_O = 9.5\text{ V}$	10 V	-	-3.8	-	-3.2	-	-2.5	mA
		$V_O = 13.5\text{ V}$	15 V	-	-12.0	-	-10.0	-	-8.0	mA
I_{OL}	LOW-level output current	$V_O = 0.4\text{ V}$;	4.75 V	3.5	-	2.9	-	2.3	-	mA
		$V_O = 0.5\text{ V}$;	10 V	12.0	-	10.0	-	8.0	-	mA
		$V_O = 1.5\text{ V}$;	15 V	24.0	-	20.0	-	16.0	-	mA
I_I	input leakage current	$V_I = 0\text{ V}$ or 15 V	15 V	-	0.3	-	0.3	-	1.0	μA
I_{DD}	supply current	$I_O = 0\text{ A}$	5 V	-	4	-	4	-	30	μA
			10 V	-	8	-	8	-	60	μA
			15 V	-	16	-	16	-	120	μA
I_{OZ}	OFF-state output current		15 V	-	1.6	-	1.6	-	12.0	μA
C_I	input capacitance			-	-	-	7.5	-	-	pF

10. Dynamic characteristics

Table 7. Dynamic characteristics

$V_{SS} = 0\text{ V}$; $T_{amb} = 25\text{ °C}$; for test circuit see [Figure 6](#); unless otherwise specified.

Symbol	Parameter	Conditions	V _{DD}	Extrapolation formula ^[1]	Min	Typ	Max	Unit
t _{PHL}	HIGH to LOW propagation delay	nAn to nȳn; see Figure 4	5 V	70 ns + (0.20 ns/pF)C _L	-	80	160	ns
			10 V	31 ns + (0.08 ns/pF)C _L	-	35	70	ns
			15 V	22 ns + (0.06 ns/pF)C _L	-	25	50	ns
t _{PLH}	LOW to HIGH propagation delay	nAn to nȳn; see Figure 4	5 V	50 ns + (0.30 ns/pF)C _L	-	65	130	ns
			10 V	24 ns + (0.13 ns/pF)C _L	-	30	60	ns
			15 V	23 ns + (0.05 ns/pF)C _L	-	25	50	ns
t _{THL}	HIGH to LOW output transition time	see Figure 4	5 V	15 ns + (0.30 ns/pF)C _L	-	30	60	ns
			10 V	10 ns + (0.11 ns/pF)C _L	-	15	30	ns
			15 V	7 ns + (0.07 ns/pF)C _L	-	10	20	ns
t _{TLH}	LOW to HIGH output transition time	see Figure 4	5 V	10 ns + (0.50 ns/pF)C _L	-	35	70	ns
			10 V	8 ns + (0.24 ns/pF)C _L	-	20	40	ns
			15 V	6 ns + (0.18 ns/pF)C _L	-	15	30	ns
t _{PHZ}	HiGH to OFF-state propagation delay	nȳOE, to nȳn; see Figure 5	5 V		-	45	85	ns
			10 V		-	35	65	ns
			15 V		-	30	60	ns
t _{PLZ}	LOW to OFF-state propagation delay	nȳOE, to nȳn; see Figure 5	5 V		-	65	135	ns
			10 V		-	40	80	ns
			15 V		-	35	70	ns
t _{PZH}	OFF-state to HIGH propagation delay	nȳOE, to nȳn; see Figure 5	5 V		-	70	140	ns
			10 V		-	35	75	ns
			15 V		-	30	65	ns
t _{PZL}	OFF-state to LOW propagation delay	nȳOE, to nȳn; see Figure 5	5 V		-	90	185	ns
			10 V		-	40	85	ns
			15 V		-	35	70	ns

[1] The typical value of the propagation delay and transition times are calculated from the extrapolation formula as shown (C_L in pF).

Table 8. Dynamic power dissipation P_D

P_D can be calculated (in μW) from the formulas shown. V_{SS} = 0 V; t_r = t_f ≤ 20 ns; T_{amb} = 25 °C.

Symbol	Parameter	V _{DD}	Typical formula for P _D (μW)	where:
P _D	dynamic power dissipation	5 V	$P_D = 5000 \times f_i + \Sigma(f_o \times C_L) \times V_{DD}^2$	f _i = input frequency in MHz, f _o = output frequency in MHz, C _L = output load capacitance in pF, V _{DD} = supply voltage in V, Σ(C _L × f _o) = sum of the outputs.
		10 V	$P_D = 22800 \times f_i + \Sigma(f_o \times C_L) \times V_{DD}^2$	
		15 V	$P_D = 81000 \times f_i + \Sigma(f_o \times C_L) \times V_{DD}^2$	

11. AC waveforms

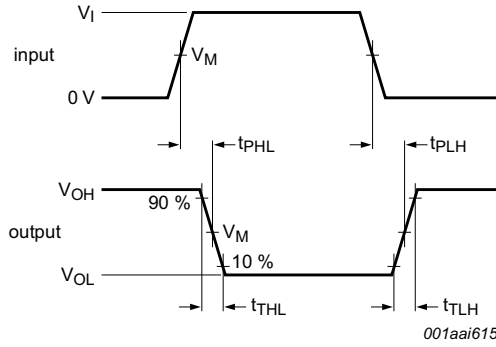

Measurement points are given in Table 9, V_{OL} and V_{OH} are typical output voltage levels that occur with the output load.

Fig 4. Input (nAn) to output (nYn) propagation delays

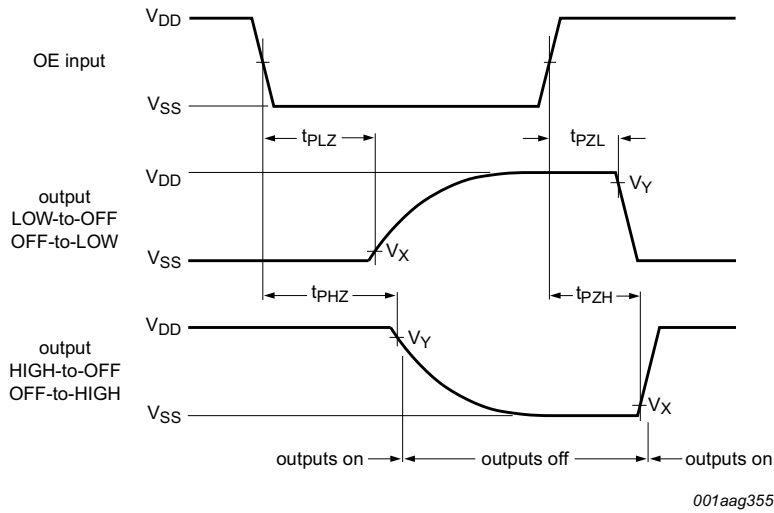

Measurement points are given in Table 9, V_{OL} and V_{OH} are typical output voltage levels that occur with the output load.

Fig 5. 3-state enable and disable times

Table 9. Measurement points

Supply voltage	Input	Output		
V_{DD}	V_M	V_M	V_X	V_Y
5 V to 15 V	$0.5V_{DD}$	$0.5V_{DD}$	$0.1V_{DD}$	$0.9V_{DD}$

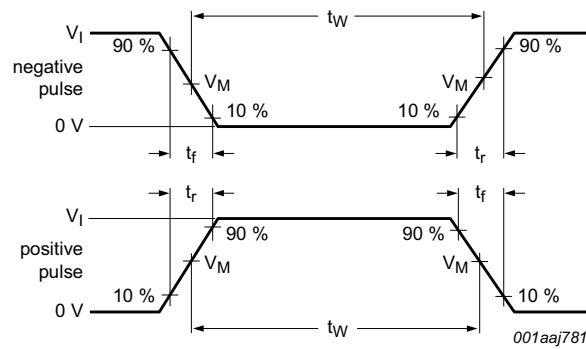

a. Input waveform

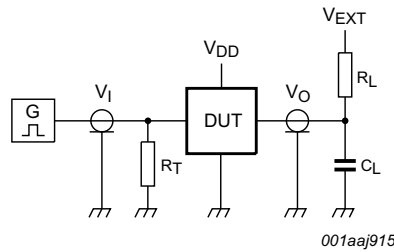

b. Test circuit

Test and measurement data is given in [Table 10](#).

Definitions test circuit:

DUT = Device Under Test.

R_L = Load resistance;

C_L = Load capacitance including jig and probe capacitance.

R_T = Termination resistance should be equal to output impedance Z_o of the pulse generator.

V_{EXT} = External voltage for measuring switching times.

Fig 6. Test circuit for measuring switching times

Table 10. Test data

Supply voltage	Input		Load		V_{EXT}		
V_{DD}	V_I	t_r, t_f	C_L	R_L	t_{PLH}, t_{PHL}	t_{PLZ}, t_{PZL}	t_{PHZ}, t_{PZH}
5 V to 15 V	V_{DD}	≤ 20 ns	50 pF	1 k Ω	open	V_{DD}	GND

12. Package outline

SO16: plastic small outline package; 16 leads; body width 3.9 mm

SOT109-1

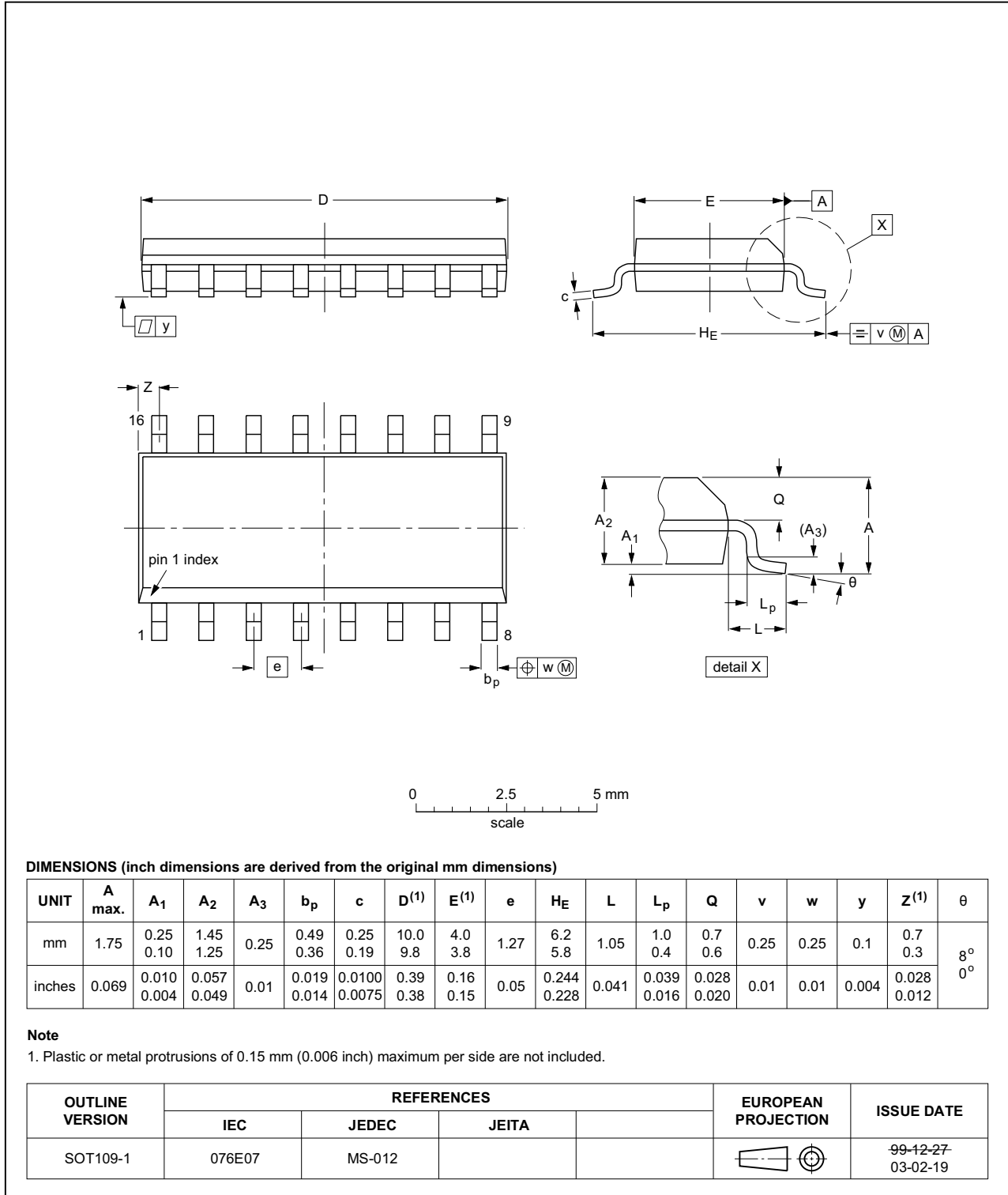

Fig 7. Package outline SOT109-1 (SO16)

13. Revision history

Table 11. Revision history

Document ID	Release date	Data sheet status	Change notice	Supersedes
HEF40098B v.9	20160318	Product data sheet	-	HEF40098B v.8
Modifications:	<ul style="list-style-type: none"> Type number HEF40098BP (SOT38-4) removed. 			
HEF40098B v.8	20111121	Product data sheet	-	HEF40098B v.7
Modifications:	<ul style="list-style-type: none"> Legal pages updated. Changes in “General description” and “Features and benefits”. Section “Applications” removed. 			
HEF40098B v.7	20110914	Product data sheet	-	HEF40098B v.6
HEF40098B v.6	20090624	Product data sheet	-	HEF40098B v.5
HEF40098B v.5	20081031	Product data sheet	-	HEF40098B v.4
HEF40098B v.4	20080731	Product data sheet	-	HEF40098B_CNV v.3
HEF40098B_CNV v.3	19950101	Product specification	-	HEF40098B_CNV v.2
HEF40098B_CNV v.2	19950101	Product specification	-	-

14. Legal information

14.1 Data sheet status

Document status ^{[1][2]}	Product status ^[3]	Definition
Objective [short] data sheet	Development	This document contains data from the objective specification for product development.
Preliminary [short] data sheet	Qualification	This document contains data from the preliminary specification.
Product [short] data sheet	Production	This document contains the product specification.

[1] Please consult the most recently issued document before initiating or completing a design.

[2] The term 'short data sheet' is explained in section "Definitions".

[3] The product status of device(s) described in this document may have changed since this document was published and may differ in case of multiple devices. The latest product status information is available on the Internet at URL <http://www.nexperia.com>.

14.2 Definitions

Draft — The document is a draft version only. The content is still under internal review and subject to formal approval, which may result in modifications or additions. Nexperia does not give any representations or warranties as to the accuracy or completeness of information included herein and shall have no liability for the consequences of use of such information.

Short data sheet — A short data sheet is an extract from a full data sheet with the same product type number(s) and title. A short data sheet is intended for quick reference only and should not be relied upon to contain detailed and full information. For detailed and full information see the relevant full data sheet, which is available on request via the local Nexperia sales office. In case of any inconsistency or conflict with the short data sheet, the full data sheet shall prevail.

Product specification — The information and data provided in a Product data sheet shall define the specification of the product as agreed between Nexperia and its customer, unless Nexperia and customer have explicitly agreed otherwise in writing. In no event however, shall an agreement be valid in which the Nexperia product is deemed to offer functions and qualities beyond those described in the Product data sheet.

14.3 Disclaimers

Limited warranty and liability — Information in this document is believed to be accurate and reliable. However, Nexperia does not give any representations or warranties, expressed or implied, as to the accuracy or completeness of such information and shall have no liability for the consequences of use of such information. Nexperia takes no responsibility for the content in this document if provided by an information source outside of Nexperia.

In no event shall Nexperia be liable for any indirect, incidental, punitive, special or consequential damages (including - without limitation - lost profits, lost savings, business interruption, costs related to the removal or replacement of any products or rework charges) whether or not such damages are based on tort (including negligence), warranty, breach of contract or any other legal theory.

Notwithstanding any damages that customer might incur for any reason whatsoever, Nexperia's aggregate and cumulative liability towards customer for the products described herein shall be limited in accordance with the *Terms and conditions of commercial sale* of Nexperia.

Right to make changes — Nexperia reserves the right to make changes to information published in this document, including without limitation specifications and product descriptions, at any time and without notice. This document supersedes and replaces all information supplied prior to the publication hereof.

Suitability for use — Nexperia products are not designed, authorized or warranted to be suitable for use in life support, life-critical or safety-critical systems or equipment, nor in applications where failure or malfunction of a Nexperia product can reasonably be expected to result in personal injury, death or severe property or environmental damage. Nexperia and its suppliers accept no liability for inclusion and/or use of Nexperia products in such equipment or applications and therefore such inclusion and/or use is at the customer's own risk.

Applications — Applications that are described herein for any of these products are for illustrative purposes only. Nexperia makes no representation or warranty that such applications will be suitable for the specified use without further testing or modification.

Customers are responsible for the design and operation of their applications and products using Nexperia products, and Nexperia accepts no liability for any assistance with applications or customer product design. It is customer's sole responsibility to determine whether the Nexperia product is suitable and fit for the customer's applications and products planned, as well as for the planned application and use of customer's third party customer(s). Customers should provide appropriate design and operating safeguards to minimize the risks associated with their applications and products.

Nexperia does not accept any liability related to any default, damage, costs or problem which is based on any weakness or default in the customer's applications or products, or the application or use by customer's third party customer(s). Customer is responsible for doing all necessary testing for the customer's applications and products using Nexperia products in order to avoid a default of the applications and the products or of the application or use by customer's third party customer(s). Nexperia does not accept any liability in this respect.

Limiting values — Stress above one or more limiting values (as defined in the Absolute Maximum Ratings System of IEC 60134) will cause permanent damage to the device. Limiting values are stress ratings only and (proper) operation of the device at these or any other conditions above those given in the Recommended operating conditions section (if present) or the Characteristics sections of this document is not warranted. Constant or repeated exposure to limiting values will permanently and irreversibly affect the quality and reliability of the device.

Terms and conditions of commercial sale — Nexperia products are sold subject to the general terms and conditions of commercial sale, as published at <http://www.nexperia.com/profile/terms>, unless otherwise agreed in a valid written individual agreement. In case an individual agreement is concluded only the terms and conditions of the respective agreement shall apply. Nexperia hereby expressly objects to applying the customer's general terms and conditions with regard to the purchase of Nexperia products by customer.

No offer to sell or license — Nothing in this document may be interpreted or construed as an offer to sell products that is open for acceptance or the grant, conveyance or implication of any license under any copyrights, patents or other industrial or intellectual property rights.

Export control — This document as well as the item(s) described herein may be subject to export control regulations. Export might require a prior authorization from competent authorities.

Non-automotive qualified products — Unless this data sheet expressly states that this specific Nexperia product is automotive qualified, the product is not suitable for automotive use. It is neither qualified nor tested in accordance with automotive testing or application requirements. Nexperia accepts no liability for inclusion and/or use of non-automotive qualified products in automotive equipment or applications.

In the event that customer uses the product for design-in and use in automotive applications to automotive specifications and standards, customer (a) shall use the product without Nexperia's warranty of the product for such automotive applications, use and specifications, and (b) whenever customer uses the product for automotive applications beyond

Nexperia's specifications such use shall be solely at customer's own risk, and (c) customer fully indemnifies Nexperia for any liability, damages or failed product claims resulting from customer design and use of the product for automotive applications beyond Nexperia's standard warranty and Nexperia's product specifications.

Translations — A non-English (translated) version of a document is for reference only. The English version shall prevail in case of any discrepancy between the translated and English versions.

14.4 Trademarks

Notice: All referenced brands, product names, service names and trademarks are the property of their respective owners.

15. Contact information

For more information, please visit: <http://www.nexperia.com>

For sales office addresses, please send an email to: salesaddresses@nexperia.com

16. Contents

1	General description	1
2	Features and benefits	1
3	Ordering information	1
4	Functional diagram	2
5	Pinning information	2
5.1	Pinning	2
5.2	Pin description	3
6	Functional description	3
7	Limiting values	3
8	Recommended operating conditions	4
9	Static characteristics	4
10	Dynamic characteristics	5
11	AC waveforms	6
12	Package outline	8
13	Revision history	9
14	Legal information	10
14.1	Data sheet status	10
14.2	Definitions	10
14.3	Disclaimers	10
14.4	Trademarks	11
15	Contact information	11
16	Contents	12